

PE632BA

N-Channel Enhancement Mode MOSFET

PRODUCT SUMMARY

$V_{(BR)DSS}$	$R_{DS(ON)}$	I_D
30V	4.5mΩ @ $V_{GS} = 10V$	53A



PDFN 3X3P

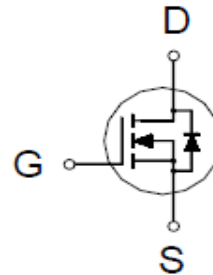

ABSOLUTE MAXIMUM RATINGS ($T_A = 25\text{ °C}$ Unless Otherwise Noted)

PARAMETERS/TEST CONDITIONS		SYMBOL	LIMITS	UNITS
Drain-Source Voltage		V_{DS}	30	V
Gate-Source Voltage		V_{GS}	±20	V
Continuous Drain Current ²	$T_C = 25\text{ °C}$	I_D	53	A
	$T_C = 100\text{ °C}$		33	
	$T_A = 25\text{ °C}$		15	
	$T_A = 70\text{ °C}$		12	
Pulsed Drain Current ¹		I_{DM}	100	
Avalanche Current		I_{AS}	37.5	
Avalanche Energy	$L = 0.1\text{mH}$	E_{AS}	70	mJ
Power Dissipation	$T_C = 25\text{ °C}$	P_D	22.7	W
	$T_C = 100\text{ °C}$		9	
	$T_A = 25\text{ °C}$		2	
	$T_A = 70\text{ °C}$		1.3	
Operating Junction & Storage Temperature Range		T_J, T_{stg}	-55 to 150	°C

THERMAL RESISTANCE RATINGS

THERMAL RESISTANCE	SYMBOL	TYPICAL	MAXIMUM	UNITS
Junction-to-Ambient ³	$R_{\theta JA}$		63	°C / W
Junction-to-Case	$R_{\theta JC}$		5.5	

¹Pulse width limited by maximum junction temperature.

²Package limitation current is 23A.

³The value of $R_{\theta JA}$ is measured with the device mounted on 1in² FR-4 board with 2oz. Copper, in a still air environment with $T_A = 25\text{ °C}$.

PE632BA

N-Channel Enhancement Mode MOSFET

ELECTRICAL CHARACTERISTICS (T_J = 25 °C, Unless Otherwise Noted)

PARAMETER	SYMBOL	TEST CONDITIONS	LIMITS			UNITS
			MIN	TYP	MAX	
STATIC						
Drain-Source Breakdown Voltage	V _{(BR)DSS}	V _{GS} = 0V, I _D = 250μA	30			V
Gate Threshold Voltage	V _{GS(th)}	V _{DS} = V _{GS} , I _D = 250μA	1.3	1.7	2.3	
Gate-Body Leakage	I _{GSS}	V _{DS} = 0V, V _{GS} = ±20V			±100	nA
Zero Gate Voltage Drain Current	I _{DSS}	V _{DS} = 24V, V _{GS} = 0V			1	μA
		V _{DS} = 20V, V _{GS} = 0V, T _J = 125 °C			10	
Drain-Source On-State Resistance ¹	R _{DS(ON)}	V _{GS} = 4.5V, I _D = 15A		4	5.5	mΩ
		V _{GS} = 10V, I _D = 15A		3.3	4.5	
Forward Transconductance ¹	g _{fs}	V _{DS} = 5V, I _D = 15A		60		S
DYNAMIC						
Input Capacitance	C _{iss}	V _{GS} = 0V, V _{DS} = 15V, f = 1MHz		2210		pF
Output Capacitance	C _{oss}			390		
Reverse Transfer Capacitance	C _{rss}			234		
Gate Resistance	R _g	V _{GS} = 0V, V _{DS} = 0V, f = 1MHz		1.4		Ω
Total Gate Charge ²	Q _{g(VGS=10V)}	V _{DS} = 15V, I _D = 15A		44.1		nC
	Q _{g(VGS=4.5V)}			23		
Gate-Source Charge ²	Q _{gs}			6		
Gate-Drain Charge ²	Q _{gd}			13		
Turn-On Delay Time ²	t _{d(on)}		V _{DD} = 15V, I _D ≅ 15A, V _{GEN} = 10V, R _G = 6Ω		25	
Rise Time ²	t _r			15		
Turn-Off Delay Time ²	t _{d(off)}			54		
Fall Time ²	t _f			17		
SOURCE-DRAIN DIODE RATINGS AND CHARACTERISTICS (T_J = 25 °C)						
Continuous Current	I _S				22.7	A
Forward Voltage ¹	V _{SD}	I _F = 15A, V _{GS} = 0V			1	V
Reverse Recovery Time	t _{rr}	I _F = 15A, di _F /dt = 100A / μS		26.7		nS
Reverse Recovery Charge	Q _{rr}			12.9		nC

¹Pulse test : Pulse Width ≤ 300 μsec, Duty Cycle ≤ 2%.

²Independent of operating temperature.

PE632BA

N-Channel Enhancement Mode MOSFET

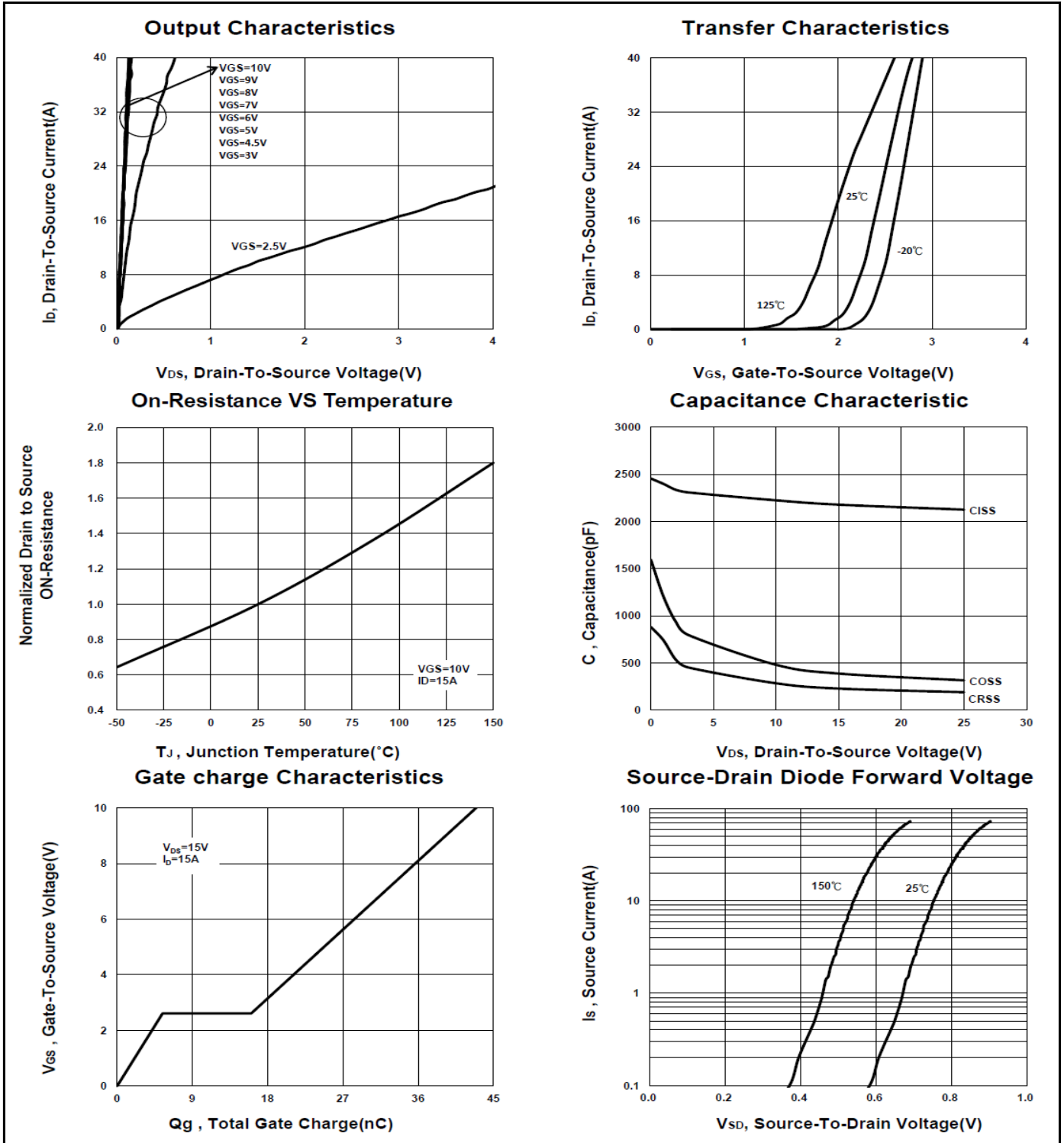

PE632BA

N-Channel Enhancement Mode MOSFET

Safe Operating Area

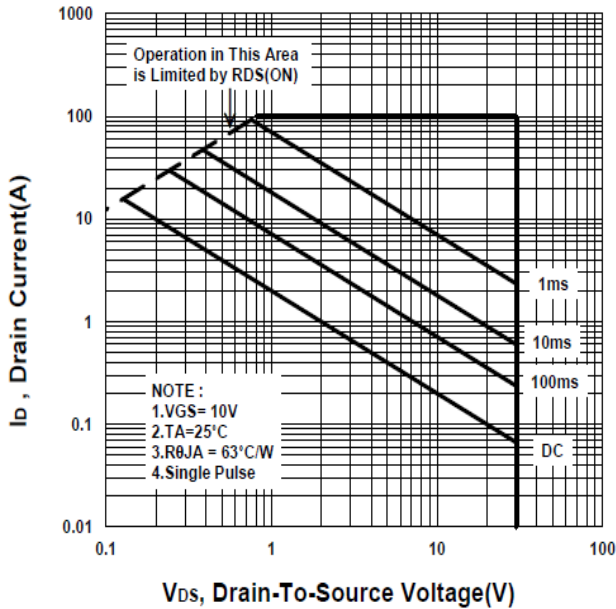

Single Pulse Maximum Power Dissipation

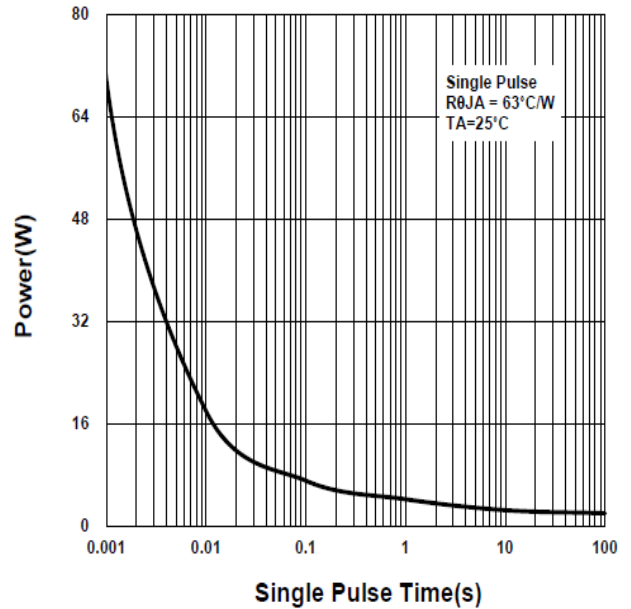

Transient Thermal Response Curve

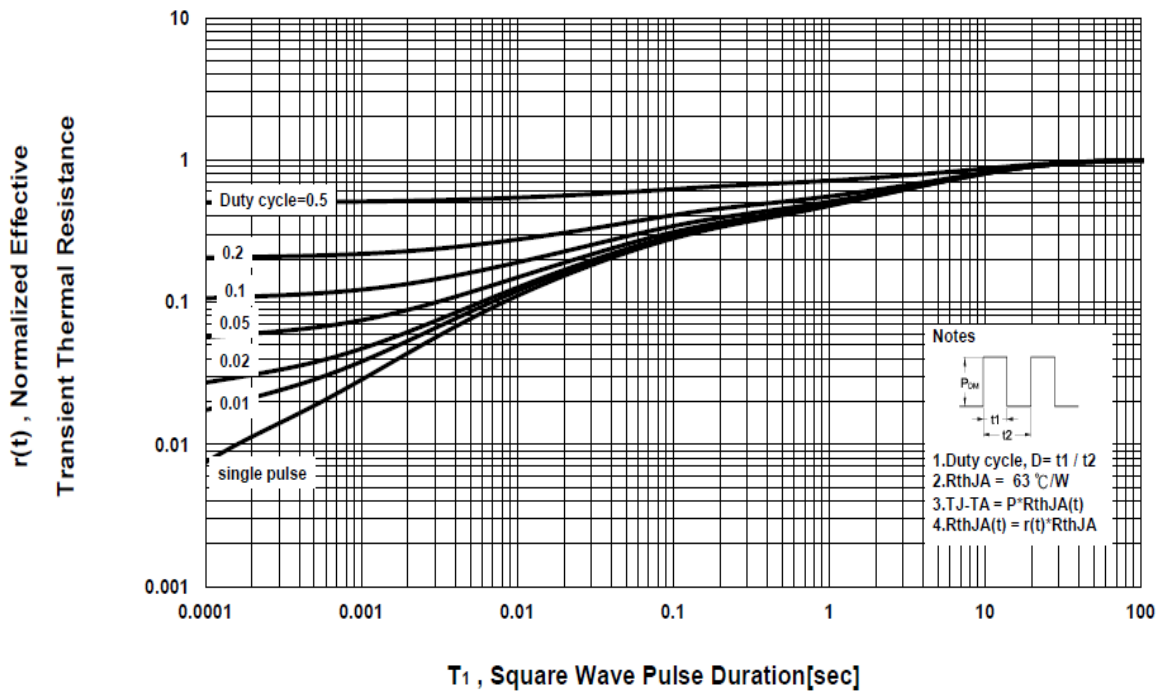

PE632BA

N-Channel Enhancement Mode MOSFET

Package Dimension

PDFN 3x3P MECHANICAL DATA

Dimension	mm			Dimension	mm		
	Min.	Typ.	Max.		Min.	Typ.	Max.
A	3		3.6	I	0.7		1.12
B	2.88		3.2	J	0.1		0.33
C	2.9		3.2	K	0.6		
D	1.98		2.69	L	0°	10°	12°
E	3		3.6	M	0.14		0.41
F	0		0.455	N	0.6		0.7
G	1.47		2.2	O	0.12		0.36
H	0.15		0.56	P	0		0.2

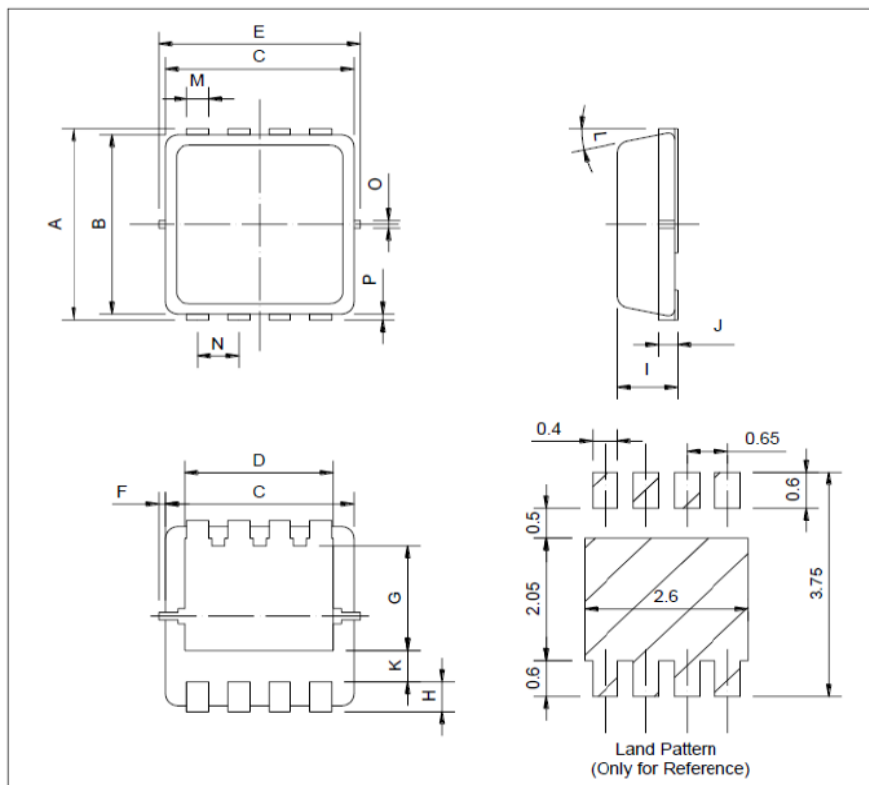

PE632BA

N-Channel Enhancement Mode MOSFET

A. Marking Information(此产品代码为: H5)

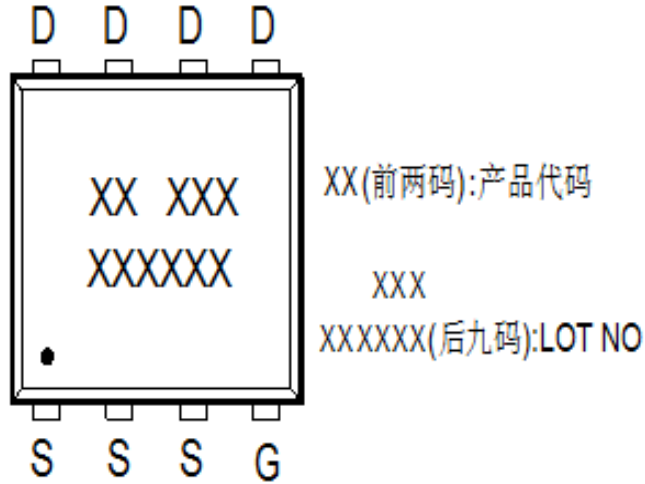

B. Tape&Reel Information:5000pcs/Reel

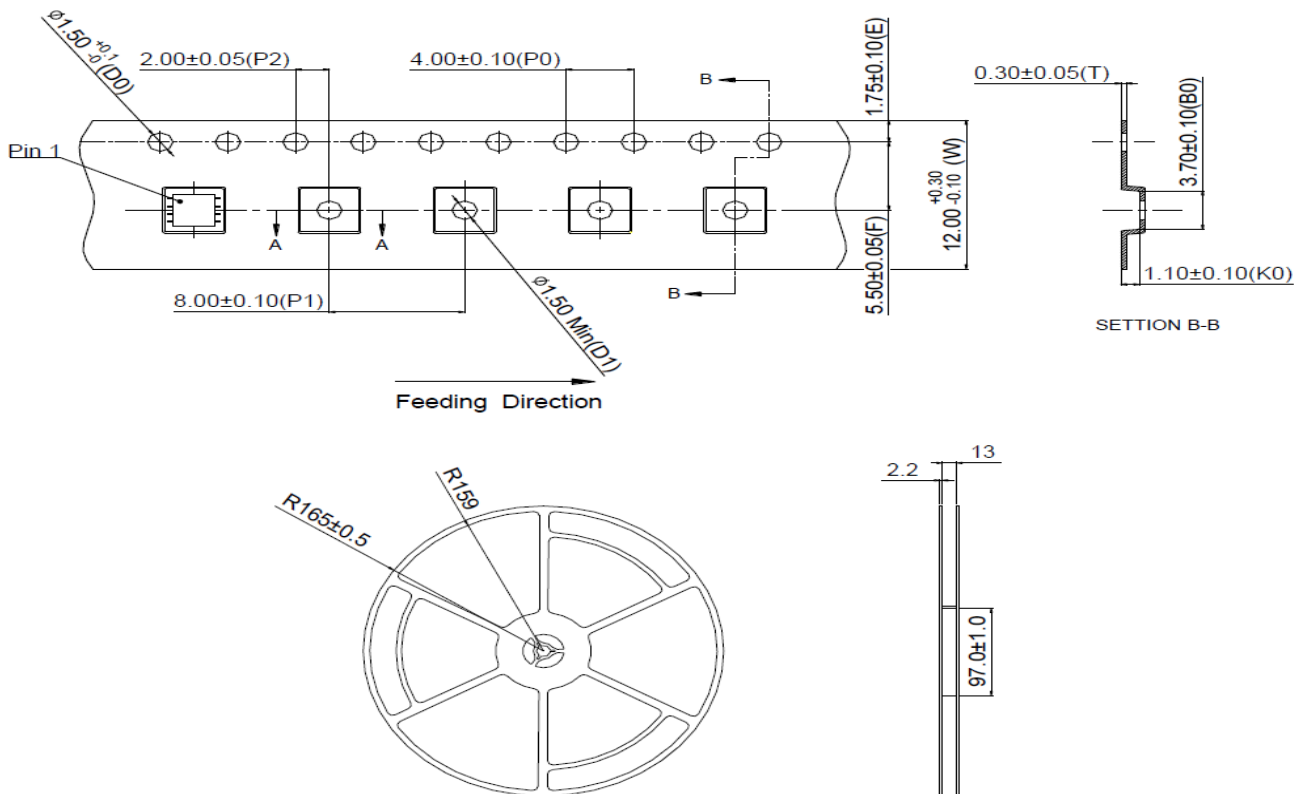

PE632BA

N-Channel Enhancement Mode MOSFET

C. Lot No.&Date Code rule

1.Lot No.

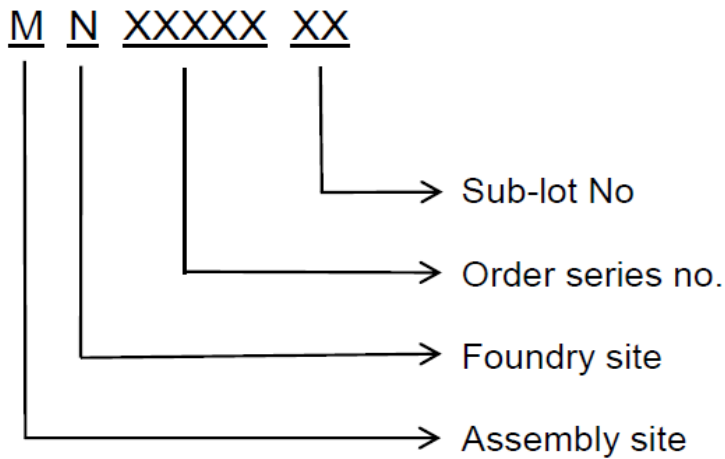

2.Date Code

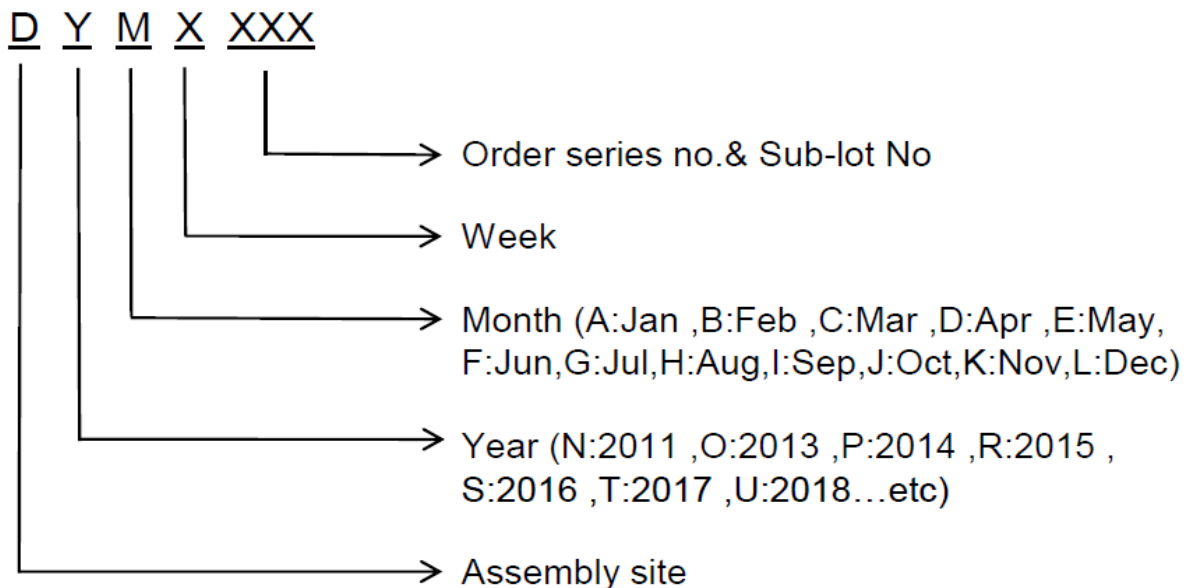



PE632BA

N-Channel Enhancement Mode MOSFET

D.Label rule

标签内容(Label content)



1	Label Size	30 * 90 mm
2	Font style	Times New Roman or Arial (或可区分英文”0”和数字”0”，”G和”Q”的字型即可)
3	Great Power	Height: 4 mm
4	Package	Height: 2 mm
5	Date	Height: 2 mm Shipping date: YYYY/MM/DD, ex. 2008/09/12
6	Device	Height: 3 mm (Max: 16 Digit)
7	Lot	Height: 3 mm (Max: 9 Digit) Sub lot
8	D/C	Height: 3 mm (Max: 7 Digit)
9	QTY	Height: 3 mm (Max: 6 Digit) Thousand mark is no needed
10	Pb Free label	 Diameter: 1 cm bottom color: Green Font color: Black Font style: Arial
11	Halogen Free label	 Diameter: 1 cm bottom color: Green Font color: Black Font style: Arial
12	Scan info	Device / Lot / D/C / QTY , Insert “ / “ between every parts. for example: P3055LDG/G12345601/GGG2301/2000 DPI (Dots per inch): Over 300 dpi Code : Code 128 Height: 6 mm at least